

Infusion stands

CATALOGUE

Pump carriers / Furniture / Hygiene centre / SAM

**Our infusion holders
have a lot in common
in all variations
of our models:**

**They are all measured
by high safety and hygiene
standards. They are robust,
stable and steadfast.**

**Easy to clean and
easy to handle.**

**They can be used almost anywhere and are
the perfect product for every requirement.**



The provita Infusion stands



mobile

robust

hygienic

**We offer state-of-the-art solutions
for a variety of applications**

Infusion stands

Contents



Normal care unit

IV pole for the daily patient care



Intensive Care Unit/Pump Carrier

High-quality infusion stands for use in intensive care medicine



OP

OP-compatible infusion stands with welded base construction



MRI

MRI approved infusion stands for use in magnetic resonance environments



Urology

Special IV poles for the urology care unit



Children's care unit

Infusion stands in child-friendly design



Home care

Infusion stands for use in private environments



Infuboy

For large movement radius



Accessories

Practical accessories for all IV pole series



Infusion stands

Infusion stands with adaptations to beds, operating tables or walls



Hygiene centre

Hygiene centres offer mobile hygiene directly on site



SAM

The transfer chair for many applications



Treatment furniture

Versatile furniture for doctor practices and clinics

Normal care unit

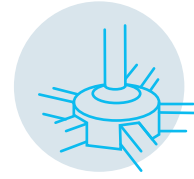

The best infusion stands for the daily patient care

The proven solution for
normal hospital operation.

INFUSIONS STANDS For the normal care unit

Material Chrome-plated steel /
Stainless steel

Castors Twin castors /
Single castors

Height adjustment Screw system or
Single-handed system



Stainless steel
(1.4301)
for best hygienic
properties



High-gloss
chrome-plated,
3-layer system



Bottle holders
according the
standards



High quality
castors



Medical device
tested according to
DIN EN 60601



Shipping optimized
packaging (up to
100 pieces on one
pallet)



Short assembly
time, only 2 – 3
minutes (base
assembly with only
one screw)



Many different
configurations

Normal care unit
Infusion stands

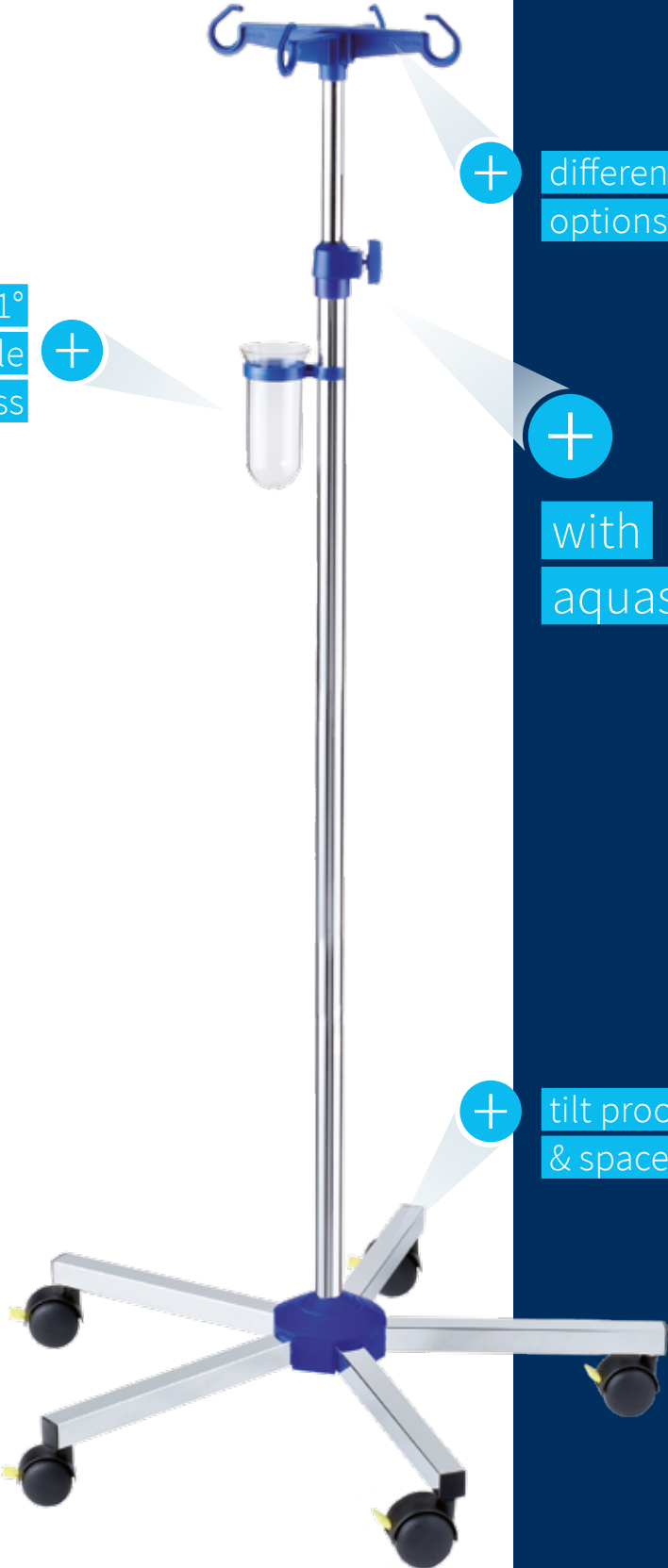

+ different options

+ up to 121° sterilisable drip glass

+ with aquastop

+ tilt proof & space saving



Here you see two configurations of the height adjustment (screw & single-handed - the original)

Made in Germany



For further accessories see page 44 ff. and/or provita.de

Normal care unit
Infusion stands



-  **SET-UP TIME**
2 - 3 minutes
-  **DIN EN 60601**
3rd Edition
-  **SUITABLE FOR**
electro-medical devices



Different bottle holders

I-N41221
Our recommendation
for the normal care unit

Total weight approx. 6.1 kg

Base diameter 635 mm

Easy
to configure

I-N a) b) c) d) e)

Or directly at
provita.de

Material / colour	a)	Height adjustment	d)
Stainless steel / blue	1	Single-handed (2.2 kg)* (max. extension 2,150 mm)	1
Chrome-plated steel / blue	4	Screw (4.5 kg)* (max. extension 2,150 mm)	2
Castors	b)	Bottle holder	e)
Twin castors 50 mm	1	Plastic 2.0 kg / hook	1
Single castors 80 mm	2	Stainless steel to screw in 2.0 kg / hook	2
		Stainless steel to plug in 2.0 kg / hook	3
Base weight	c)		
Non weighted approx. 2.2 kg*	1		
Weighted approx. 4.5 kg*	2		

* Series I-N, non weighted, only suitable for use with gravity infusion

Normal care unit
Infusion stands

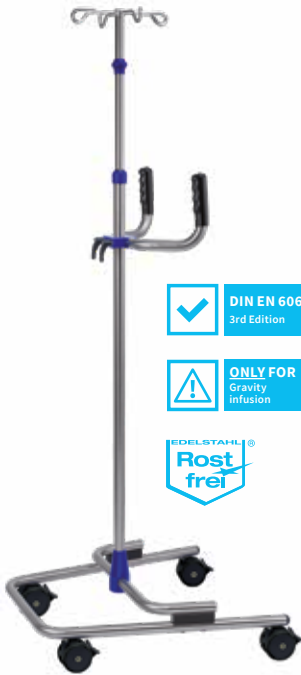

✓ **DIN EN 60601**
3rd Edition

⚠ **ONLY FOR**
Gravity infusion

EDELSTAHL®
Rost frei



✓ **DIN EN 60601**
3rd Edition

EDELSTAHL®
Rost frei

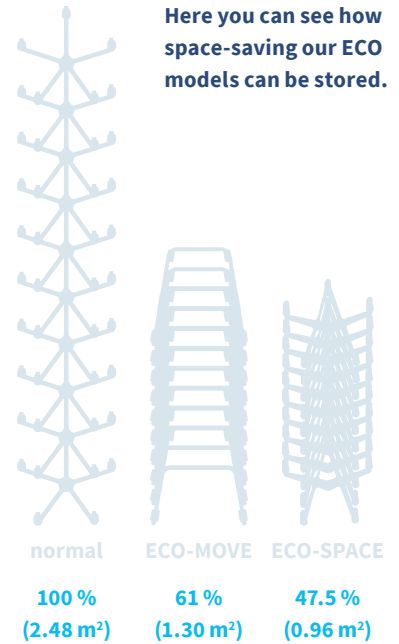

ECO-MOVE
Stumble-free manoeuvrability

Material Stainless steel / Aluminium

Castors Twin castors Ø 75 mm

Base weight 4.7 kg

Height adjustment Single-handed system

Bottle holder Stainless steel 4 hooks – 2.0 kg/hook

Regulating range 1,330 mm – 2,200 mm

Total weight 6.8 kg

Base dimension 595 × 620 mm

I-S14212



Please order pushing handle separately (Z-ECO001)

ECO-SPACE
Space-saving base construction

Material Chrome-plated steel / Stainless steel

Castors Single castors Ø 75 mm

Base weight 2.25 kg

Height adjustment Screw or single-handed system

Bottle holder Stainless steel 4 hooks – 2.0 kg/hook

Regulating range
Single-handed system approx. 1,290 mm – 2,130 mm
Screw system approx. 1,350 mm – 2,220 mm

Total weight 3.5 kg

Base diameter 590 mm

Stainless steel

Single-handed system I-S12112

Chrome-plated steel

Screw height adjustment I-S42122



For technical data see provita.de

Normal care unit Infusion stands



✓ **DIN EN 60601**
3rd Edition

⚡ **SUITABLE FOR**
electro-medical
devices

LOW-GRAVITY Extremely low centre of gravity for tilt resistant movement

Material Chrome-plated steel

Castors Twin castors Ø 75 mm

Base weight 6.0 kg

Height adjustment Single-handed system

Bottle holder Plastic 4 hooks – 2.0 kg / hook

Regulating range approx. 1,425 mm – 2,140 mm

Total weight approx. 7.6 kg

Base diameter 600 mm

I-L11112

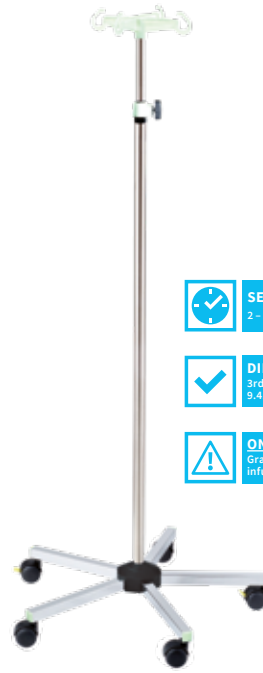

🕒 **SET-UP TIME**
2 – 3 minutes

✓ **DIN EN 60601**
3rd Edition Section
9.4.2.1 | 9.4.2.2

⚠️ **ONLY FOR**
Gravity
infusion

NIGHT LINE Fluorescence eases night care

Material Chrome-plated steel

Castors Twin castors Ø 50 mm

Base weight 1.9 kg

Height adjustment Screw system

Bottle holder Plastic 4 hooks – 2.0 kg / hook

Regulating range approx. 1,170 mm – 2,020 mm

Total weight approx. 3.9 kg

Base diameter 635 mm

I-NL1121



For technical data
see provita.de



Intensive care unit

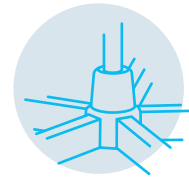

The high-quality infusion stands for intensive care units

Mobile solutions
for intensive care medicine.

INFUSION STANDS For the intensive care unit



Stainless steel
(1.4301) for best
hygienic properties



Loadable solution,
up to 50 kg depend-
ing on model



Bottle holders
according to the
standards

Material Stainless steel / Aluminium

Castors Twin castors / Single castors

Height adjustment Screw system or
Single-handed system



High quality,
low- noise castors



Medical device
tested according to
DIN EN 60601



Shipping optimized
packaging (up to
100 pieces on one
pallet)

Intensive care unit
Infusion stands

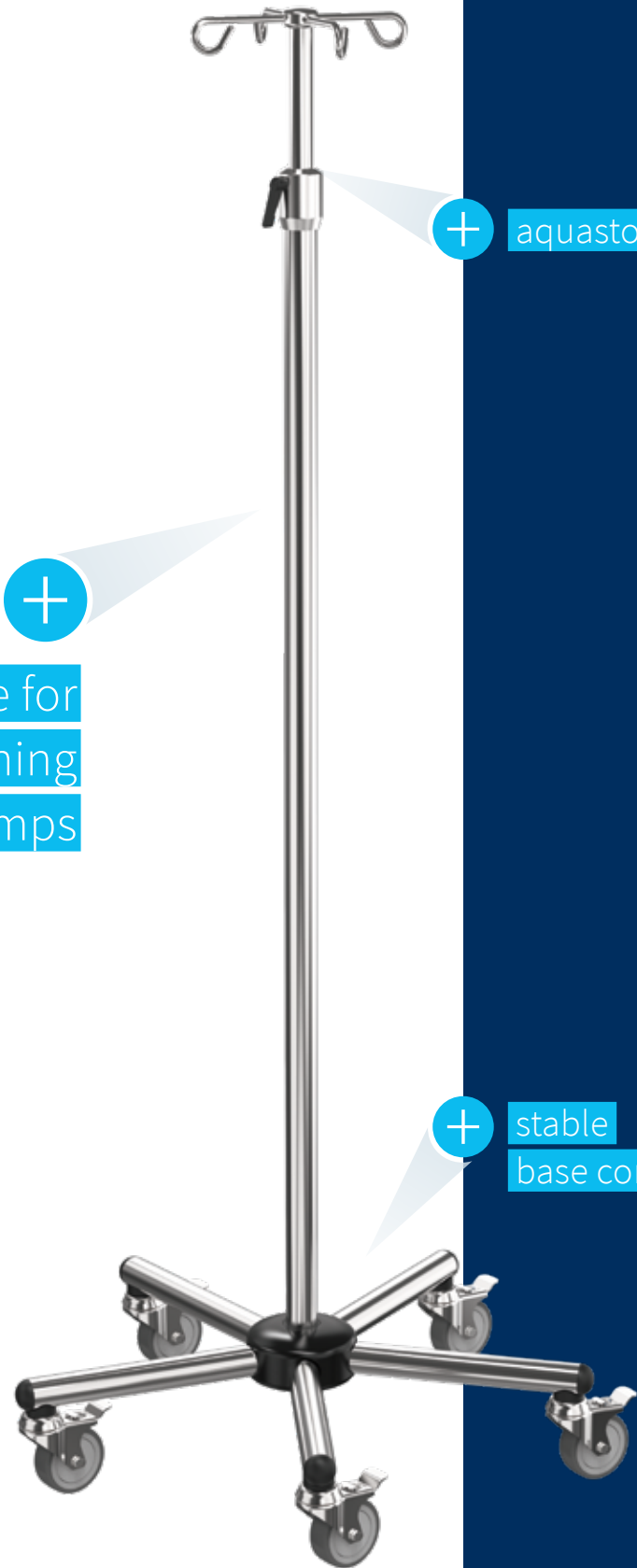

+ aquastop

+

suitable for
attaching
infusion pumps

+ stable
base construction



For further accessories see page 44 ff. and/or provita.de

Intensive care unit

Infusion stands



DIN EN 60601
3rd Edition



SUITABLE FOR
electro-medical
devices



weighted version with
blue-grey plastic parts



I-I12212

Our recommendation for the intensive care unit

Regulating range approx. 1,500 mm – 2,210 mm

Total weight approx. 8.6 kg (with drip glass and holder)

Base diameter 680 mm

Length of outer tube 1,200 mm

Easy to
configure

I-I a) b) c) d) e)

Or directly at
provita.de

Material / colour

Stainless steel / blue

a)

1

Height adjustment

Single-handed (max. extension 2,210 mm)

Screw (max. extension 2,270 mm)

d)

1

2

Castors

Single castors 80 mm

Apparatus castors 75 mm

b)

2

3

Bottle holder

Plastic 2.0 kg / hook

Stainless steel to screw in 2.0 kg / hook

Stainless steel to plug in 2.0 kg / hook

Stainless steel to screw in 5.0 kg / hook

Bottle bar 4 hooks*

Bottle bar 6 hooks*

e)

1

2

3

4

5

6

Base weight

Non weighted approx. 2.6 kg

Weighted approx. 6.5 kg

c)

1

2

* for models with
weighted base only

Intensive care unit

Premium Care



I-PRE001 High load capacity (weighted base)



I-PRE002 Good load capacity (non-weighted base)



Material Stainless steel / Aluminium

Castors Twin castors Ø 75 mm / Apparatus castors Ø 75mm

Height adjustment Single-handed system

Bottle holder Stainless steel 4 hooks – 2.0 kg/hook

Regulating range 1,520 mm – 2,295 mm

Base leg profile Ø 33.7 mm

Load capacity 18 kg

Tube diameter 25 / 18 mm

Length of outer tube 1,200 mm

Base diameter 630 mm

Base weight 8.9 kg

Total weight 11 kg

With twin castors I-PRE001

With apparatus castors I-PRE011

Material Stainless steel / Aluminium

Castors Twin castors Ø 75 mm / Apparatus castors Ø 75mm

Height adjustment Single-handed system

Bottle holder Stainless steel 4 hooks – 2.0 kg/hook

Regulating range 1,465 mm – 2,180 mm

Base leg profile Ø 25 mm

Load capacity 13 kg

Tube diameter 25 / 18 mm

Length of outer tube 1,200 mm

Base diameter 630 mm

Base weight 4.9 kg

Total weight 7 kg

With twin castors I-PRE002

With apparatus castors I-PRE012



All versions available with
twin castors or apparatus castors



For technical data
see provita.de

Intensive care unit

Premium Care



DIN EN 60601
3rd Edition



SUITABLE FOR
electro-medical
devices

Stainless steel
screw height
adjustment

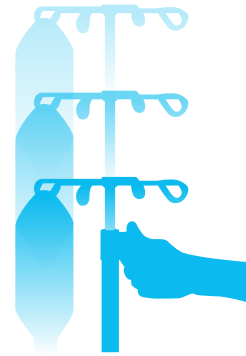

With Softdrop system!



All versions available with
twin castors or apparatus
castors

I-PRE003
Very high
load capacity



Material Stainless steel / Aluminium

Castors Twin castors Ø 75 mm / Apparatus castors Ø 75mm

Height adjustment Screw system with Softdrop feature

Bottle holder Stainless steel 4 hooks – 5.0 kg/hook

Regulating range 1,430 mm – 2,260 mm

Base leg profile Ø 33.7 mm

Load capacity 32 kg

Tube diameter 33.7 / 25 mm

Length of outer tube 1,200 mm

Base diameter 630 mm

Base weight 8.9 kg

Total weight 12 kg



**High-quality anodized
special coating to prevent
paint from coming off**

With twin castors I-PRE003

With apparatus castors I-PRE013

**Recommended accessories for
Premium Care (see p. 50)**

Intensive care unit

Premium Care

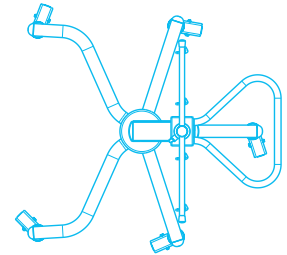

With curved arms

I-PRE004 Best hygienic properties due to round base legs



Material Stainless steel / Aluminium

Castors Twin castors Ø 75 mm / Apparatus castors Ø 75mm

Height adjustment Single-handed system

Bottle holder Stainless steel 4 hooks – 2.0 kg/hook

Regulating range 1,520 mm – 2,225 mm

Base leg profile Ø 33.7 mm

Load capacity 13 kg

Tube diameter 25 / 18 mm

Length of outer tube 1,200 mm

Base diameter 630 mm

Base weight 4.7 kg

Total weight 7 kg

With twin castors I-PRE004

With apparatus castors I-PRE014

PUMP CARRIER I-PRE100 Ideal operability due to curved base legs



Material Stainless steel / Aluminium

Castors Apparatus castors Ø 75mm

Height adjustment Screw system

Bottle bar Stainless steel 4 hooks – 2.0 kg/hook

Regulating range 1,835 mm – 2,100 mm

Base leg profile Ø 33.7 mm

Load capacity 45 kg

Tube diameter 33.7 / 25 mm

Length of outer tube 1,500 mm

Base diameter 660 / 844 mm

Total weight 16 kg

I-PRE100



For technical data
see provita.de

Intensive care unit
Gravity infusion stand



**DÜSSELDORF
UNIVERSITY MODEL**
Stable
base construction



Regulating range approx. 1,490 mm – 2,250 mm

Tube diameter Ø 33,7 / Ø 25 mm

Length of outer tube 1,300 mm

Base diameter 680 mm

Total weight approx. 10 kg

Base weight 6.6 kg

Easy
to configure

I-D a) b) c) d) e)

Or directly at
provita.de

Material / colour

Stainless steel

a)

0

Height adjustment

Screw system with Softdrop feature

d)

2

Castors

Single castors 80 mm

Apparatus castors 75 mm

b)

2

3

Bottle holder

Stainless steel to plug in

2.0 kg / hook

Stainless steel to screw in

5.0 kg / hook

e)

3

4

Base weight

Non weighted

c)

1

Intensive care unit
Device carrier for heavy loads



✓ **DIN EN 60601**
3rd Edition

⚡ **SUITABLE FOR**
electro-medical
devices



ISP UNITS
Twist-proof stand
construction

Material Stainless steel / Aluminium

Castors Twin castors Ø 125 mm / Single castors Ø 80 mm

Height adjustment Screw system (anti-twist)

Bottle bar Stainless steel 6 hooks – 2.0 kg / hook

Regulating range approx. 1,710 mm – 2,240 mm

Total weight approx. 25 kg

Tube diameter Ø 38 mm / SQR 25 mm

Length of outer tube 1,420 mm

Base diameter 860 mm



anti-twist due to square inner tube

Twin castors
(max. load 50 kg)



Single castors
(max. load 25 kg)



Base model I-P02226

With 5 equipment rails I-PA2226

With pump holder frame I-PB2226

Base model I-P02227

With 5 equipment rails I-PA2227

With pump holder frame I-PB2227



For technical data
see provita.de

OR



The hygiene-friendly infusion stands for the operating theatre

The solution for the
highest demands.

INFUSION STANDS For the operating theatre



Stainless steel
(1.4301) for
best hygienic
properties



Seamless base
construction,
electro-polished
surface



Loadable solution,
up to 30 kg
depending on
model

Material Stainless steel

Castors Twin castors / Single castors

Height adjustment Screw system or
Single-handed system



**Medical device
tested according to
DIN EN 60601**



made exclusively
of stainless
materials

+ aquastop

+ suitable
for attaching
infusion pumps

+ hygiene-friendly
due to seamless
welding



For further accessories see page 44 ff. and/or provita.de



I-012112

Our recommendation for the operating theatre

Height adjustment Screw system or Single-handed system

Tube diameter 25 / 18 mm

Length of outer tube 1,000 mm

Total weight approx. 3.6 kg

Base weight 1.9 kg

Base diameter 635 mm

Easy
to configure

I-O a) b) c) d) e)

Or directly at
provita.de

Base leg profile

30 × 15 mm

a)

1

Height adjustment

d)

Single-handed
(max. extension 2,150 mm)

1

Screw (max. extension 2,150 mm)

2

Castors

Twin castors 50 mm

Single castors 80 mm

b)

1

2

Bottle holder

e)

Stainless steel to screw in
2.0 kg / hook

1

Base weight

Non weighted (1.9 kg)

Weighted (4.3 kg)

c)

1

2



I-023232 The OR heavy-duty alternative



Height adjustment Screw system or Single-handed system

Tube diameter 33.7 / 25 mm

Length of outer tube 1,200 mm

Total weight approx. 14.3 kg

Base weight 11 kg

Base diameter 635 mm

Easy
to configure

I-O a) b) c) d) e)

Or directly at
provita.de

Base leg profile

45 × 25 mm

a)

2

Castors

Twin castors 75 mm

b)

3

Base weight

Weighted (11 kg)

c)

2

Height adjustment

Single-handed
(max. extension 2,250 mm)

Stainless steel screw system
with Softdrop feature
(max. extension 2,270 mm)

d)

1

3

Bottle holder

Stainless steel to screw in
2.0 kg / hook

Stainless steel to screw in
5.0 kg / hook

e)

2

4



For technical data
see provita.de

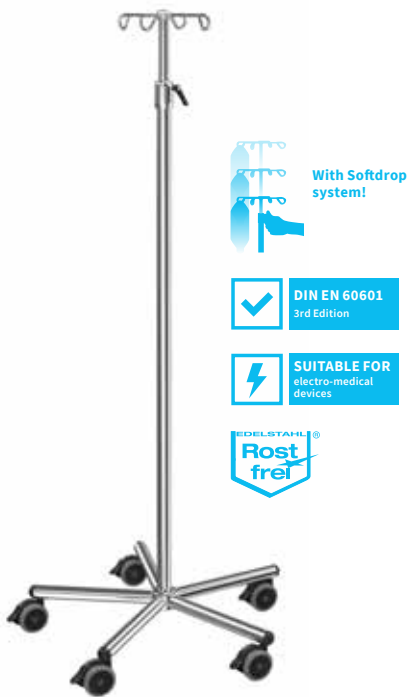

I-OPRE01

The premium solution for the operating theatre



Material Stainless steel

Castors Twin castors Ø 75 mm

Height adjustment Screw system with Softdrop feature

Bottle holder Stainless steel, 4 hooks – 5.0 kg/hook

Regulating range 1,475 mm – 2,470 mm

Base leg profile Ø 33.7 mm

Load capacity 25 kg

Tube diameter 33.7 / 25 mm

Length of outer tube 1,200 mm

Base diameter 680 mm

Base weight 8.7 kg

Total weight 12 kg



For technical data
see provita.de



MRI

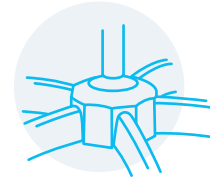

The magnetic resonance infusion stands

For the voltage tension in medical technology.



MR suitable for 1.5 or 3.0 Tesla, minimum distance to device 30 cm



MR conditional



Short assembly time, only 2 – 3 minutes (base assembly with only one screw)

INFUSION STAND For use in the MRI

Material Stainless steel / Aluminium

Castors Twin castors / Single castors

Height adjustment Screw system

MRI
Infusion stands



+
for devices
up to 3 Tesla

+ non-magnetic
material



I-M12121 Our recommendation for MRI up to 1.5 Tesla

Material Stainless steel

Castors Twin castors Ø 50 mm / Single castors Ø 80 mm

Height adjustment Screw system

Bottle holder Plastic 2.0 kg / hook

Regulating range approx. 1,250–2,150 mm

Tube diameter 25 / 18 mm

Length of outer tube 1,000 mm

Base leg profile 30 × 15 mm

Total weight approx. 3.6 kg with drip glass and holder

Base weight approx. 1.9 kg

Twin castors I-M11121

Single castors I-M12121



Arm & leg rest
suitable for use
with MRI
(Article No.
S2112013)
(see p. 67)



further
MRI-products
upon request



MRI INFUSION STAND For devices up to 3 Tesla with magnet-free brass castor pins

Material Aluminium

Castors Twin castors Ø 50 mm

Base weight 1.4 kg

Height adjustment Screw system

Bottle holder Plastic 4 hooks – 2.0 kg / hook

Regulating range approx. 1,250 – 2,100 mm

Total weight approx. 2 kg

Base diameter 635 mm

I-M91121



For technical data
see provita.de

Urology



Extra high infusion stands for the urology care unit

For high pressure build-up
and heavy rinsing solutions.

INFUSION STANDS For the urology



Stainless steel
(1.4301) for
best hygienic
properties



Extra high
extension for
higher pressure
of rinsing solutions



Medical device
tested according to
DIN EN 60601

Material Stainless steel

Castors Twin castors / Single castors /
Apparatus castors

Height adjustment Screw system

Urology
Infusion stands

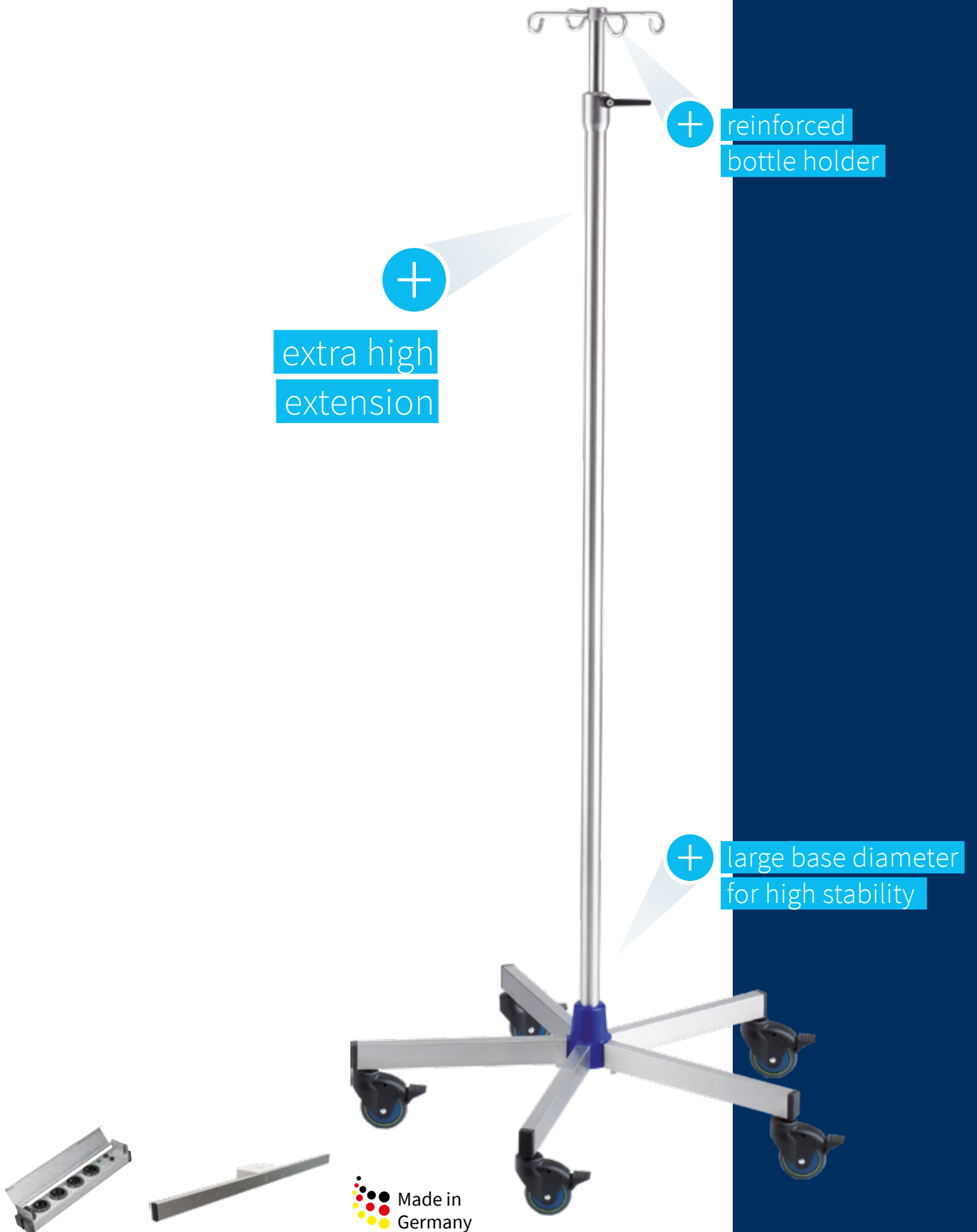

For further accessories see page 44 ff. and/or provita.de



I-U02224 Very high extension

Material Stainless steel

Castors Single castors Ø 80 mm

Base weight 7.5 kg

Height adjustment Stainless steel screw system with Softdrop feature

Bottle holder Stainless steel 4 hooks – 5.0 kg/hook

Regulating range approx. 1,890 mm – 2,895 mm

Total weight 13.2 kg

Base diameter 800 mm

I-U02224



I-U02234 With hydraulic height adjustment

Material Stainless steel

Castors Twin castors Ø 75 mm

Height adjustment manual hydraulic through foot pedal

Bottle holder Stainless steel 3 hooks – 5.0 kg/hook

Regulating range approx. 1,630 – 2,625 mm

Total weight 25 kg

Base diameter 654 mm

I-U02234

**manual hydraulic
foot pedal system**





back-friendly
height adjustment
through foot switch



I-U02237
**Electric height adjustment
and long battery life**

- Material** Stainless steel
- Castors** Apparatus castors Ø 75 mm
- Height adjustment** through foot switch
- Bottle holder** Stainless steel 3 hooks – 10.0 kg/hook
- Regulating range** approx. 1,500 mm – 2,650 mm
- Total weight** 36.5 kg
- Base diameter** 550 × 550 mm

protection bumpers



I-U02237



For technical data
see provita.de

Children's care unit

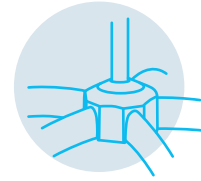

The colourful infusion stands for the children's care unit

Multi-coloured combinations that brighten up everyday hospital life.

INFUSION STANDS For the children's care unit



Colourful figures provide distraction (plane, mouse)



Short assembly time, only 2 – 3 minutes (base assembly with only one screw)



Shipping optimized packaging (up to 100 pieces on one pallet)

Material Aluminium / Plastic

Castors Twin castors

Height adjustment Screw system





CHILDREN-INFUSION STAND »RAINBOW« In colourful design with figures castors

Material Aluminium / Plastic

Castors Twin castors

Base weight 1.6 kg

Height adjustment Screw system

Bottle holder Plastic

Regulating range 1,275 – 2,100 mm

Total weight approx. 3.0 kg

Base diameter 635 mm

Tube diameter 25 / 18 mm



With air plane castors

Red, black, yellow I-HA4125

Yellow, blue, green I-HA4130

With mouse castors

Green, black, yellow I-HA4126



For technical data
see provita.de



S. children's care unit lamps



Home care

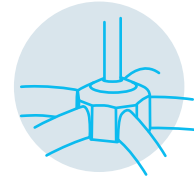

Infusion stand for care at home

Simply remain mobile.

INFUSION STAND For the private environment

Material Stainless steel / Chrome-plated steel / Aluminium / Plastic

Castors/bases Twin castors / non-slip adjustable feet

Height adjustment Screw system



Short assembly time, only 2 – 3 minutes (base assembly with only one screw)



Only for gravity infusion



Bottle holders according to the standards



Shipping optimized packaging (up to 100 pieces on one pallet)

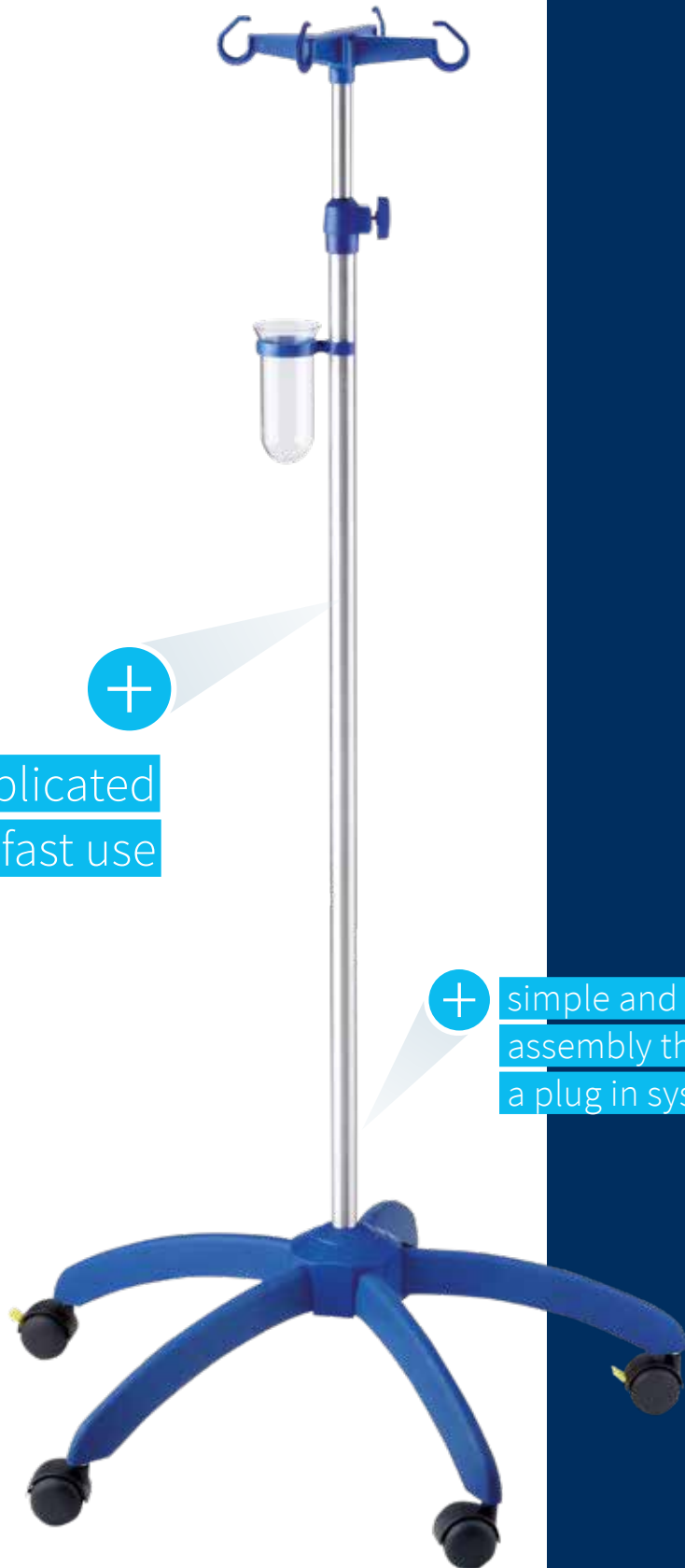

+
uncomplicated
and fast use

+ simple and quick
assembly thanks to
a plug in system

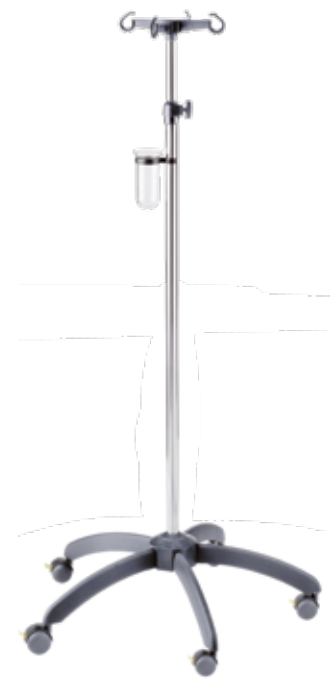
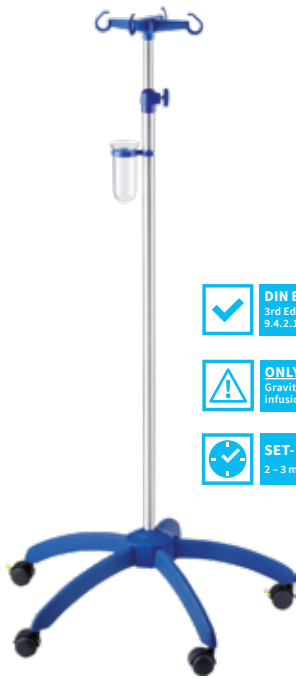

I-H71121

Our recommendation for the care at home

Material Aluminium

Castors Twin castors Ø 50 mm

Base weight 1.6 kg

Height adjustment Screw system

Bottle holder Plastic 4 hooks – 2.0 kg/hook

Regulating range approx. 1,250 mm – 2,100 mm

Total weight approx. 3.0 kg

Base diameter 660 mm

Blue

Stainless steel I-H11121

Aluminium I-H71121

Chrome-plated steel I-H41121

Black

Stainless steel I-H21121

Aluminium I-H81121

Chrome-plated steel I-H51121

Grey

Stainless steel I-H31121

Aluminium I-H91121

Chrome-plated steel I-H61121



FOLDABLE INFUSION STAND

**Our recommendation
while in transit**

Material Aluminium/Plastic

Base non-slip adjustable bases

Height adjustment Screw system

Bottle holder 2 hooks – 0.5 kg/hook

Regulating range approx. 830 mm – 1,780 mm

Total weight approx. 2.0 kg

Load capacity 1.0 kg

Transport size 750 × 100 × 100 mm

Tube diameter 20 / 15 / 11 mm

Base diameter 680 mm

I-H84132



TABLE INFUSION STAND

For ambulatory use

Material Stainless steel/Plastic

Height adjustment Screw system

Bottle holder Plastic 4 hooks – 2.0 kg/hook

Regulating range approx. 510 mm – 730 mm

Total weight approx. 3.0 kg

Base diameter 305 mm

Special feature with 5 short, weighted base leg sections and rubberised anti-slip bases

I4440002



incl. carrying bag
(Bag size: approx. 750 × 100 × 100 mm)

**+ especially suitable for rescue
care services as well as travelling
patients**



**For technical data
see provita.de**

Infuboy

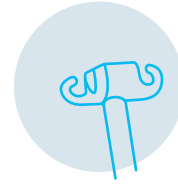

Infusion backpack that creates independence

For movement and grip freedom
during infusion.

INFUBOY I-WALK01

Material Stainless steel / Polyester

Height adjustment Screw system

Hooks 2 pieces, 2.0 kg / hook

Regulating range 700 – 850 mm

Dimensions approx. 350 × 795 mm

Total weight 1.6 kg



Infuboy
Infusion backpack

+
for the patient
freedom of movement

+ fabric part
washable at 60°

+
lightweight
materials ensure
high wearing comfort



- + comfortable height adjustment using screw system
- + easy to clean
- + no risk of injury thanks to automatically retracting hooks

- + enables patient to keep both hands free
- + plastic frame without toxic ingredients
- + completely recyclable



Infusion stands

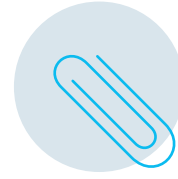

The right accessories

To complete and / or modify your infusion stand.



SCREW IN BOTTLE HOLDER

4 hooks M6
with M10 threaded pin

Load capacity 2.0 kg per hook

Weight approx. 0.15 kg

Stainless steel Z2N06352

Chrome-plated steel Z2S06367



INSERT BOTTLE HOLDER

4 hooks, for infusion stands without female thread, for round tube \varnothing 18 mm

Load capacity 2.0 kg per hook

Material Plastic

Weight approx. 0.06 kg

Green Z2K0645G

Blue Z2K0645D

Red Z2K0645H

Grey Z2K0645N

Black Z2K0645R

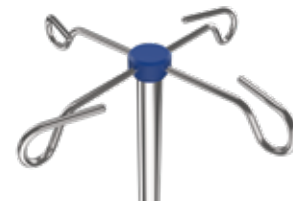

PLUG IN BOTTLE HOLDER

4 hooks for infusion stands without female thread for round tube \varnothing 18 mm

Load capacity 2.0 kg per hook

Material Stainless steel

Weight approx. 0.15 kg

Z2N06392



REINFORCED BOTTLE HOLDER

4 hooks M8 with M10 threaded pin
to screw in a M10 female thread

Load capacity 5.0 kg per hook

Material Stainless steel

Weight approx. 0.2 kg

Z2N06102



BOTTLE BAR

M6 hooks, M10 threaded pin
to screw in a M10 female thread

Load capacity 2.0 kg per hook

Material Stainless steel

4 hooks, length 500 mm Z2N06552

6 hooks, length 600 mm Z2N06542



INFUSION BOTTLE HOLDER

2 bottle hooks and 2 bottle baskets
for infusion stands with or without female thread
for round tube Ø 18 mm

Load capacity 2.0 kg per basket or hook

Weight approx. 0.4 kg

Holder with Stainless steel middle section, for screwing, Stainless steel (hooks)
Z2N65632

Holder with Aluminium middle section, for screwing, chrome-plated (hooks +
baskets), Z2S65737

Holder with Plastic middle section, for plugging in, chrome-plated (hooks + baskets),
Z2S65837

IMPORTANT:

We would like to expressly point out that not all bottle holder/bar variants/accessories are suitable for products with a lightweight base construction. For safety reasons, you should take advantage of this opportunity and contact our sales team for advice on 'tilt resistance' and the requirements of DIN EN 60601. Changes to products also jeopardise approval according to DIN EN 60601. We would be pleased to provide you with further information about this.



For technical data
see provita.de

Accessories
Infusion stands



PUSHING HANDLE*

For round tube Ø 25 mm,
height adjustable through
2 fixing screws

Material Stainless steel / Aluminium

Colour of fastening clamps blue

Weight approx. 0.55 kg

Z2N07982

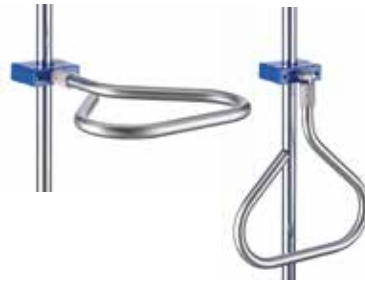

**FOLDABLE
PUSHING HANDLE***

For round tube Ø 25 mm

Material Stainless steel / Aluminium

Colour of fastening clamps blue

Weight approx. 0.9 kg

Z2N07952



**ECO MOVE
PUSHING HANDLE ***

For round tube Ø 25 mm

Material Stainless steel / Aluminium

Colour of fastening clamps blue

Handle protection on handle ends

Z-ECO001



**PUSHING HANDLE
WITH FASTENING KNOB
FOR A QUICK RELEASE***

For round tube Ø 25 mm,
height adjustable through knob

Material Plastic

Colour black

Temperature resistant up to 60°C

Z2K0698R



PUSHING HANDLE*

For round tube Ø 25 mm,
height adjustable through handwheel

Material Stainless steel

Colour of plastic parts black

Weight approx. 0.4 kg

Z2N06982

***Caution:** Pushing handles are not permitted for I-N and I-H series infusion stands.

Accessories

Infusion stands



RECTANGULAR TRAY**

For round tube Ø 25 mm,
height adjustable through handwheel
with an all around safety edge

Material Stainless steel / Aluminium

Size 315 × 275 mm

Weight approx. 2.75 kg

Z2N63422



MONITOR TRAY**

Round tube Ø 25 mm
height adjustable through handwheel
with lateral safety edge

Material Steel, white coated / Aluminium

Size 240 × 248 mm

Weight approx. 2.75 kg

K2S7043A



CIRCULAR TRAY**

For round tube Ø 25 mm
with circumferential safety edge

Material Stainless steel

Diameter 370 mm

Weight approx. 2.9 kg

Z2N64422

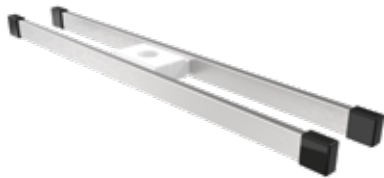

TWIN EQUIPMENT RAIL*

For round tube Ø 25 mm

Material Aluminium / Stainless steel

Weight approx. 1.3 kg

Optional for round tube Ø 33.7 mm /
Ø 38 mm

Length of rail 558 mm

Z2N06932



IDENTIFIER SLEEVE

For round tube Ø 25 mm
to label infusion stands for an
easier station or room allocation

Material Polycarbonate

Weight approx. 0.1 kg

H2K0625-



COMPACT RAIL (SPLITTED)

For round tube Ø 38 mm

Material Aluminium

Equipment rail 25 × 10 mm,
circumferential

Load capacity 30.0 kg

Size 110 × 110 mm

Weight approx. 0.9 kg

Z2N09303

****Caution:** In general not retrofittable. We will be glad to advice you if required.



For technical data
see provita.de

Accessories

Infusion stands



PUMP HOLDER FOR 2 DEVICES**

For round tube Ø 25 mm, height adjustable through handwheel, for infusion pumps and other equipment

Material Stainless steel

Weight approx. 1.0 kg

Z2N06312



PUMP HOLDER FOR 4 DEVICES**

For round tube Ø 25 mm, height adjustable through two handwheels, for infusion pumps and other equipment

Material Stainless steel

Weight approx. 1.2 kg

Z2N06292

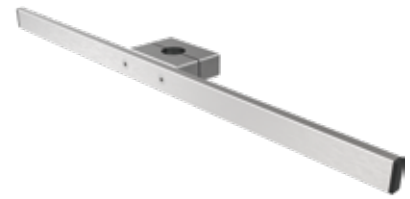

EQUIPMENT RAIL

For retrofitting to round tubes Ø 25 / 38 mm, height adjustable through two fixing screws

Material Stainless steel

Profile 25 × 10 mm

Length 558 mm

Load capacity approx. 8.0 kg

Weight approx. 0.9 kg

For round tube Ø 25 mm H2N70432

For round tube Ø 33.7 mm H2N70342

For round tube Ø 38 mm H2N70332



TUBE CLAMP

For fastening accessory to the infusion stand, Ø 25–50 mm

Material Aluminium, coated

Bracket Ø 18 mm

Weight approx. 0.13 kg

White Z2N0502A

Silver Z2N0502S



WALL MOUNT

To fasten stands directly on the wall with 4 drilled holes

Material Aluminium, white coated

Bracket Ø 18 mm / optional for Ø 25 mm

Size approx. 80 × 70 × 80 mm

With threaded pin Z2N0617A

****Caution:** In general not retrofittable. We will be glad to advise you this if required.



MEDICAL APPROVED PLUGBOARD “VARI MED”

Protected against unintentional opening

Housing material Aluminium, anodized

Operating display green

Fuse 2-pole T6, 3AH

Protective cover automatic locking, can only be opened with a tool

Cable supply line 3 or 5 m (spiral cable 1 – 3 m), with medical plug

Cable cross section 1.5 mm² / 2.5 mm²

Traceability by manufacturer date on cable, supply line and connector

Plug-in slots 4 or 6, plug rotated 90° with sufficient space

Fastening Universal clamp for equipment rail and round tube

Optional Antibacterial feed line / plug

For mobile use (cable size 1,5 mm²)

4-plug Z2K06384

4-plug, dual fused, 3 m cable supply Z2K07014

4-plug, dual fused, 5 m cable supply Z2K07015

4-plug, spiral cable Z2K07024

4-plug, dual fused, spiral cable Z2K07034

6-plug, 3 m cable supply Z2K06394

6-plug, dual fused, 5 m cable supply Z2K07114

6-plug, dual fused, 3 m cable supply Z2K07124

For medical fixed installations (cable size 2,5 mm²)

4-plug Z2K07044

4-plug, dual fused Z2K07054

For medical fixed installations (cable size 2,5 mm²) with connection possibility for grounding

4-plug, dual fused, 2.5 mm², 1.5 m, 4 × PE-connections,
PE-connection lead: 4 mm², 4 m Z2K07104

For mobile use (cable size 1,5 mm²) with connection possibility for grounding

4-plug, dual fused, 1.5 m, 4 × PE-connections, PE-connection
lead: 4 mm², 4 m Z2K07064

4-plug, dual fused, 3 m, 4 × PE-connections, PE-connection
lead: 4 mm², 4 m Z2K07074

4-plug, dual fused, 5 m, 4 × PE-connections, PE-connection
lead: 4 mm², 4 m Z2K07084

4-plug, dual fused, spiral cable 1-3 m, 4 × PE-connections,
PE-connection lead: 4 mm², 4 m Z2K07094



For vertical & horizontal mounting



For technical data
see provita.de

Accessories with quick hand fastener

for attachment on round tubes \varnothing 25 – 33.7 mm
(colour of handle: blue-grey)

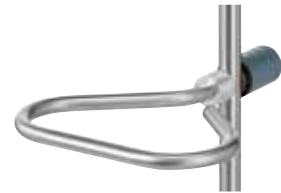

PUSHING HANDLE*

Material Stainless steel / Aluminium

Weight approx. 0.55 kg

Z-PRE006



DRAINAGE HOLDER 2 HOOKS

Material Stainless steel / Aluminium

Distance between hooks 160 mm

Load capacity 2.0 kg / hook

Weight approx. 0.5 kg

Z-PRE001



BOTTLE HOLDER 2 HOOKS

Material Stainless steel / Aluminium

Total length 460 mm

Load capacity 1.0 kg / hook

Weight approx. 0.7 kg

Z2N6661S

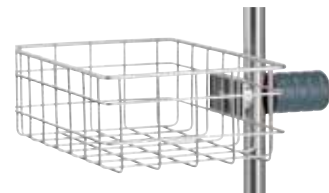

STORAGE BASKET

Material Stainless steel / Aluminium

Size 300 × 200 × 100 mm

Weight approx. 0.5 kg

Z-PRE005



PUMP HOLDER FOR 2 DEVICES

Material Stainless steel / Aluminium

Load capacity 5.0 kg (2.5 kg ea. side)

Weight approx. 0.95 kg

Z-PRE002



EQUIPMENT RAIL

Material Stainless steel / Aluminium

Size 25 × 10 × 500 mm

Load capacity 5.0 kg (2.5 kg ea. side)

Weight approx. 0.7 kg

Z-PRE004



TRAY

Material Stainless steel / Aluminium

Size 310 × 250 mm

Weight approx. 1.6 kg

Z-PRE003

***Caution:** Pushing handles are not permitted for I-N and I-H series infusion stands.



For technical data
see provita.de

Find out more

SAM

sit and move

starting on page 58



Infusion stands

Infusion poles

For a safe adaptation to beds,
operating tables or walls.



WALL STANDS

Material Stainless steel / Aluminium

Bottle holder Stainless steel 4 / 3 hooks – 2.0 kg / hook

Height adjustment Screw system

Regulating range approx. 730 – 1,040 mm / approx. 540 – 845 mm

Tube diameter 25 / 18 mm

Inner tube 2 × 90° bent / straight

Projection 200 mm

Wall holders 2 pieces with 2 holes each for M6 countersunk screws (screws are not included)

Total weight approx. 2.0 kg incl. drip glass and glass holder

Angled I-WAND01

Straight I-WAND02



WALL IV HOLDER

Material Stainless steel / Aluminium

Tube diameter 18 mm, pivotable

Carrier arm length 400 mm

Bottle hooks adjustable – 2.0 kg / hook

Weight approx. 0.8 kg

I-WAND03

INFUSION POLE Without adaption element

- Material** Stainless steel / Chrome-plated steel
- Bottle holder** Stainless steel 4 hooks – 2.0 kg / hook
- Height adjustment** Single-handed system
- Regulating range** approx. 1,080 mm – 1,680 mm
- Tube diameter** 25 / 18 mm
- Weight** approx. 2.1 kg / approx. 1.6 kg

- Stainless steel** with plastic end cap I1000702
- Chrome-plated steel** with plastic end cap I1000707



With adaptation element

For beds:
Ø 27 × L 180 mm



- Stainless steel** I1000302
- Chrome-plated steel** I1000307



INFUSION HOLDER For bed lifting pole

- Material** Plastic
- Colour** white
- Suitable** for oval tubes 32 mm
- Bottle hooks** 4 safety hooks – 2.0 kg / hook

Z2K0646A

*Further adapters and OEM stands upon request

With ball joint

For tilting and laying tables:
with universal clamp to attach
on different rail profiles and round
tubes, stepless inclinable up to 30°
in all directions



- Stainless steel with 2 hooks (90°)** I1000232
- Stainless steel with 4 hooks** I1000252



INFUSION BOTTLE HOLDER For bed lifting pole

- Material** Stainless steel / Aluminium
- Suitability** for oval and round tube profiles
- Bottle bar** 4 hooks – 2.0 kg / hook
- Length of bottle bar** 490 mm
- Locking** Double clamp with handwheel

Z2N09072



For technical data
see provita.de

Hygiene centre



Hygiene wherever is needed

The mobile hygiene station from provita medical provides easy access to hygiene where needed.



**Individual
design**



**Stainless steel
(1.4301) for best
hygienic properties**



**Can be mounted
without tools**



Modifiable

Hygiene centre
Infusion stands



Fully equipped
(19 kg total weight)

Blue S02512PB

Yellow S025120I

Silver S025120S



completely
equipped
mobile
hygiene centre



Accessories for your hygiene centre



ROLLER BASE WITH POLE

Material Stainless steel

Carrier tube L 1,500 mm, Ø 33.7 mm

Base Ø 630 mm

Castors Mono Ø 80 mm

Blue S07501PB

Yellow S075012I

Silver S075012S



GLOVE BOX HOLDER 3-fold

Material Aluminium, coated

Size 390 × 260 × 100 mm

Fastening Quick-release fastener

Weight approx. 1.5 kg

Blue Z2N655PB

Yellow Z2N6552I

Silver Z2N6552S



GLOVE BOX HOLDER 2-fold

Material Aluminium, coated

Size 280 × 270 × 100 mm

Fastening Quick-release fastener

Weight approx. 1.3 kg

Blue Z2N658PB

Yellow Z2N6585I

Silver Z2N6585S



TRAY

Material Stainless steel / Aluminium

Size 310 × 250 mm

Blue Z2N075PB

Yellow Z2N0754I

Silver Z2N0754S



LARGE STORAGE BASKET

Material Stainless steel / Aluminium

Size 460 × 460 × 150 mm

Z2N65842



SMALL STORAGE BASKET

Material Stainless steel / Aluminium

Size 300 × 200 × 100 mm

Blue Z2N659PB

Yellow Z2N6583I

Silver Z2N6583S



STORAGE BOX

2 closed individual containers

Material Stainless steel / Aluminium

Size approx. 450 × 220 × 200 mm
(single box)

Fastening Universal clamp

Z2N67142



GLOVE BOX HOLDER

3-fold adjustable

Material Stainless steel

Size approx. 400 × 210 (265) × 120 mm
(H×W×D)

Fastening Quick-release fastener

Weight 2.3 kg

Blue Z2N656PB

Yellow Z2N6560I

Silver Z2N6560S



DRIP BOWL

2 Litre

Material Stainless steel / Aluminium

Size 300 × 200 × 100 mm

Blue Z2N061PB

Yellow Z2N0616I

Silver Z2N0616S



DISINFECTANT DISPENSER

500 ml, with long lever

Material Aluminium

Blue Z2N657PB

Yellow Z2N6586I

Silver Z2N6586S



DISINFECTANT DISPENSER

500 ml,
with long lever and plastic tray

Material Aluminium

Blue Z2N660PB

Yellow Z2N6588I

Silver Z2N6588S

SAM



Mobility in health and care

The modern transfer chair for many applications –
from ambulances to museums.

SAM Sit and move

Material Stainless steel / PU foam

Wheels puncture-proof and
abrasion-resistant PU tires

Braking system automatic safety
braking system



Stainless steel
(1.4301) for best
hygienic properties



**Space-saving,
stackable**



**Suitable for
automated
washing systems**

SAM
sit and move

SAM

sit and move

various
lock and
deposit systems

space saving
and stackable

electropolished
stainless steel

sturdy – load capacity
up to 150 kg

customizable
advertising space

Made in
Germany



SAM
Basic model

Frame material Stainless steel tubing 18 – 10, Ø 32 × 2 mm electropolished

Material for armrests, backrest and seat PU foam

Armrest foldable

Design space-saving due to stackability

Max. weight load 150.0 kg

Dimensions approx. 960 × 710 × 990 mm (L × W × H)

Weight 21.0 kg

S-SAM001



SAM
Ambulance version

Frame material Stainless steel tubing 18 – 10, Ø 32 × 2 mm, coated in RAL 3020 – traffic red

Material for armrests, backrest and seat PU foam

Armrest Foldable

Legrest PU foam. Comfortable stored on the side. The legrest can be mounted on the right or left while in use. Securing is done through a locking bolt.

Design space-saving due to stackability

Max. weight load 150.0 kg

Dimensions approx. 960 × 710 × 990 mm (L × W × H)

Weight 23.0 kg

S-SAM003

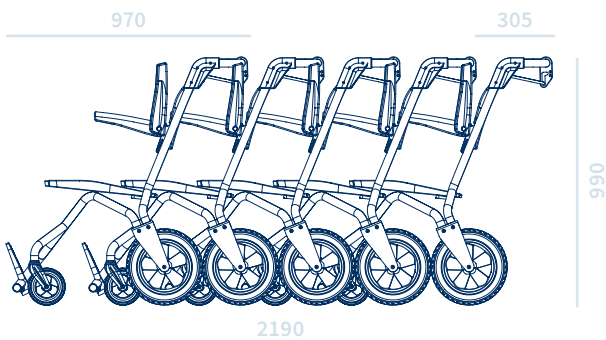

designed to save space



The legrest can be mounted on the right or left side.



SAM With customizable advertising set

Frame material Stainless steel tubing 18 – 10, Ø 32 × 2 mm electropolished

Material for armrests, backrest and seat PU foam

Armrest Foldable

Design space-saving due to stackability

Max. weight load 150.0 kg

Dimensions approx. 960 × 710 × 990 mm (L × W × H)

Weight 21.0 kg

Advertising set consisting of 2 stickers on rear wheel fork and 2 stickers on side advertising plate

S-SAM004



We will be glad to produce the SAM according to your colour requirements. Talk to us.



+49 (0) 21 93 / 51 05 - 0



For technical data
see provita.de

Accessories for SAM



LOCK*

Cost-effective
& safe

Housing material high-quality,
resistant plastic

Lock cylinder material Brass

Surface nickel-plated

Z-SAM014



DEPOSIT SYSTEM*

Card

Housing material high-quality,
resistant plastic

Material of key and chain Stainless
steel

Z-SAM007



DEPOSIT SYSTEM*

Coin

Housing material high-quality,
resistant plastic

Material of key and chain Stainless
steel

Coins 50 Ct., 1 € and 2 €

Z-SAM003



SAFETY BELT

Fast
and safe

Material Polyester

Z-SAM002



HOLDER

For an
oxygen bottle

Material Stainless steel

Z-SAM012



CANE HOLDER

Suitable for
various walking aids

Material Stainless steel

Z-SAM013

*not retrofittable



STORAGE SPACE

Practical
and stable

Material of stowage space Stainless steel

Load capacity 15 kg

Max. size of luggage approx.
400 × 500 × 200 mm

Z-SAM011



INFUSION POLE

Especially for the
transfer chair

Material Stainless steel

Tube diameter 18 / 14 mm

Bottle holder Stainless steel 2 hooks
90° – 2.0 kg / hook

Height adjustment Single-handed
system

Regulating range approx.
920 – 1,100 mm

Z-SAM001



UNIVERSAL BAG

Especially for the
transfer chair

Material Nylon fabric with PVC coating

Dimensions approx. 375 × 315 × 65 mm
(L × W × D)

Z-SAM008



PARKING STATION

Free standing

Dimensions approx. 844 × 1,817 mm

Plate size approx. 720 × 800 mm

Z-SAM004



PARKING STATION

For wall mounting

Dimensions approx. 777 × 940 mm

Plate size approx. 720 × 800 mm

Z-SAM005



For technical data
see provita.de

Treatment furniture

The right assortment

For a professional and smooth treatment.



OR PRIVACY PROTECTION / SCREENING To hang surgical drapes

Material Stainless steel / Aluminium

Tube diameter 25 / 18 mm

Length approx. 1,500 – 2,800 mm

Fastening 2 Universal fastening clamps

Total weight approx. 4.0 kg

Z2N08582



SCREEN CART With fire resistant screen

Material Steel coated

Colour white

Size approx. 980 × 520 × 1,800 mm

Castors Twin castors Ø 50 mm

Total weight approx. 7.0 kg

S888000A

Surgical drapes are not included in scope of delivery



STORAGE CART

Removable shelves
for easy cleaning

Material Stainless steel

Overall dimension 420 × 420 × 800 mm

Tube diameter 18 mm

Castors Twin castors Ø 50 mm

Total weight approx. 11.0 kg

T2170032



BOWL HOLDER

Safe holding of liquids,
solutions and cloths

Material Stainless steel

Bowl holder with handle (ball handle)

Number of bowls 1 or 2 pieces (each 6 l)

Bowl diameter 320 mm

Height 825 mm

Base diameter approx. 635 mm

Castors Twin castors Ø 50 mm

Total weight approx. 7.8 kg

With 1 bowl S0111902

With 2 bowls S0112002



optional: also
available with
seamless welded base



For technical data
see provita.de



ARMREST / LEGREST Ergonomic support pad

Material Chrome-plated steel

Pad material PU-foam

Regulating range approx. 680 mm – 910 mm

Pad size 300 × 100 mm

Base diameter 635 mm

Castors Twin castors Ø 50 mm

Total weight approx. 3.0 kg

Chrome-plated steel

Single-handed system on anti-slide feet S1112007

Single-handed system with castors S1112017

Screw system on anti-slide feet S2102037

Screw system with castors S2112027



ARMREST/LEGREST Rotatable, can be tilted and swivelled

Material Chrome-plated steel, white-coated

Pad material PU-foam

Regulating range approx. 595 mm – 795 mm

Pad size 300 × 100 mm

Base diameter 635 mm

Castors Twin castors Ø 50 mm

Total weight approx. 3.0 kg

White coated

Screw system with castors S211202A

Anti-slip feet





MRI ARM- / LEGREST

Non-magnetic materials

Material Aluminium

Base material Plastic, ultramarine blue

Pad material PU- foam

Regulating range approx. 825 mm – 1,240 mm

Base diameter 635 mm

Castors Twin castors Ø 50 mm

Screw system S2112013



INSTRUMENT TABLE

Plate with safety edging

Material Stainless steel/Plastic

Colour of plastic parts blue

Plate size 300 × 200 mm

Pole 1,000 mm

Castors Twin castors Ø 50 mm

Total weight approx. 4.0 kg

19972302



For technical data
see provita.de



DEVICE CART
Weighted base construction

Material Stainless steel / Aluminium

Centre tube Ø 38 × 1,000 mm

Plate size 300 × 200 mm

Multi-purpose basket 230 × 230 × 250 mm

Castors Single castors Ø 80 mm

Total weight approx. 22.5 kg

19972202



KICK BUCKET
For consumables during an operation

Material Stainless steel

Capacity approx. 12 Litre

Castors Single castors Ø 80 mm

Size Ø 330 × 440 mm

Total weight approx. 3.75 kg

19972302



OXYGEN BOTTLE STAND

Transport cart for large oxygen bottles

Material Steel, coated

Colour white

Application for 10 litre – O₂ bottles

Securing with lashing strap

Height 880 mm

Base diameter 635 mm

Castors Twin castors Ø 50 mm

Total weight approx. 4.5 kg

S013190A



HOOK CART

Professional screening of surgical towels

Material Stainless steel

Number of hooks 120

Size approx. 475 × 1,200 × 1,600 mm

Castors Apparatus castors Ø 75 mm

Total weight approx. 27.0 kg

Z2N09102



For technical data
see provita.de

OEM solutions

**We develop customer-specific products
in cooperation with leading manufacturers
of medical technology.**

**We would be pleased to develop products
according to your requirements.**



We can fulfil
almost all
your wishes.



Adapters for bed infusion poles

Made of Plastic



With adapting elements



Adapter pin





You have further questions?

**We will be glad
to help you personally.**

**Just give us a quick ring:
+49 (0) 21 93 / 51 05 - 0**

**Or e-mail us:
info@provita.de**

For more than 50 years, our family business has been one of the leading manufacturers in medical technology.



personal

experienced

motivated

Our general terms and conditions apply. Errors, misprints and changes reserved.

© Copyright: provita medical gmbh & co. kg, October 2019

Reproduction as well as duplication, also in extracts, are not permitted without permission of provita medical.

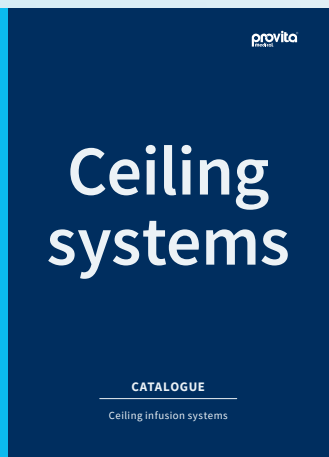
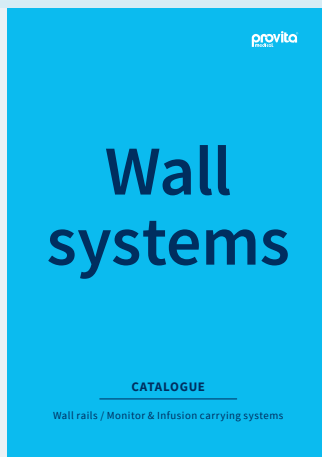
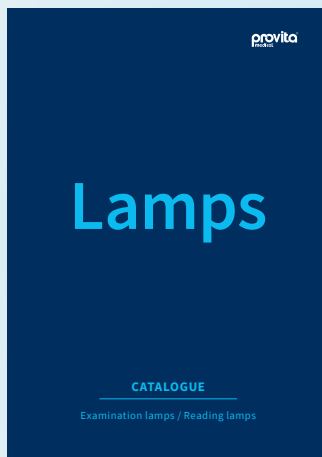

Auf der Huhfuhr 8
42929 Wermelskirchen
Germany

Phone +49 (0) 21 93 / 51 05 - 0
Fax +49 (0) 21 93 / 51 05 - 269

info@provita.de
www.provita.de

